



Stampa Ritaglia GIOCA!



© 2017 Prism Art & Design Limited



3-5 ANNI
MEMORY
I pericoli a casa



Cane

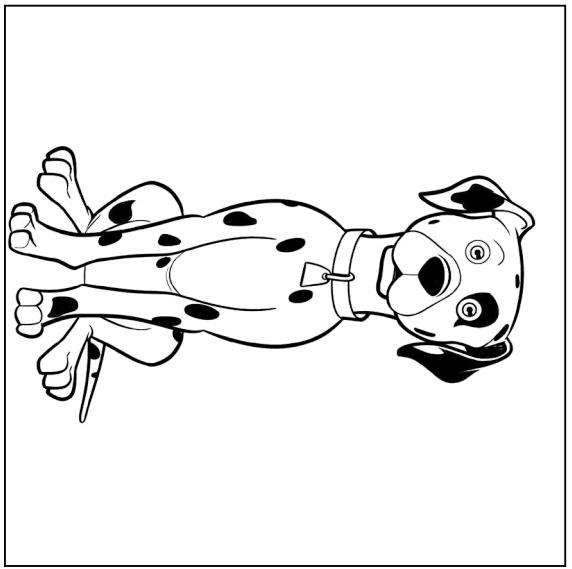

3-5 ANNI
MEMORY
I pericoli a casa



Accendino

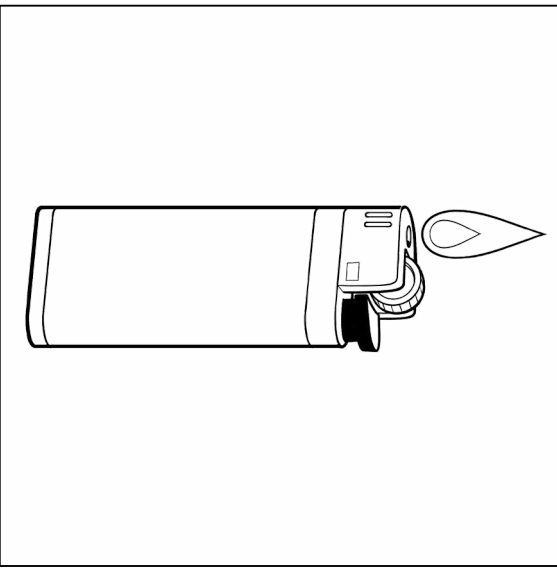

3-5 ANNI
MEMORY
I pericoli a casa



Pentola

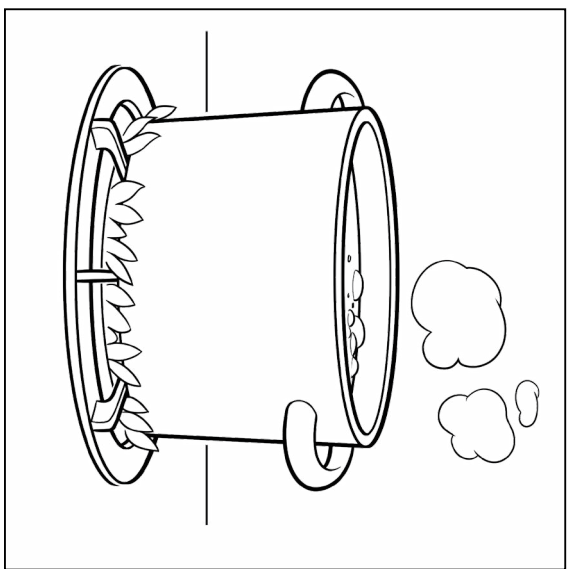

3-5 ANNI
MEMORY
I pericoli a casa



Fiaccone



3-5 ANNI
MEMORY
I pericoli a casa



Scale

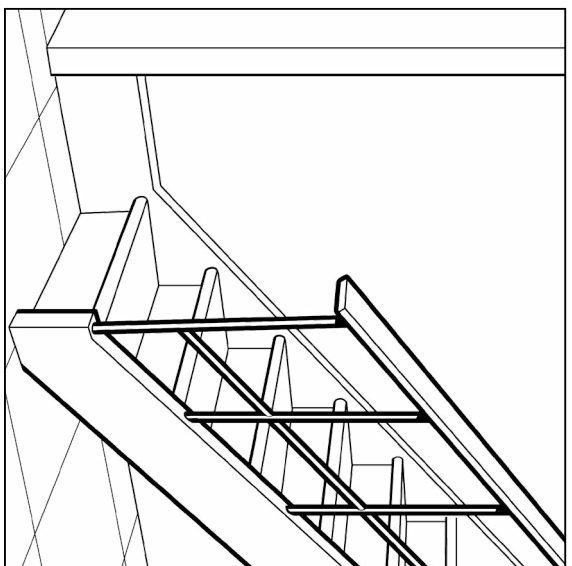

STAMPA
Ritaglia
GIOCA!

3-5 ANNI
MEMORY
I pericoli a casa

3-5 ANNI
MEMORY
I pericoli a casa



Cane

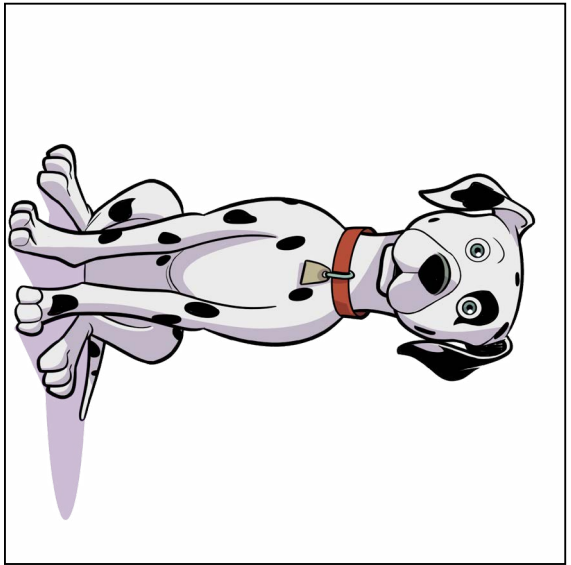

3-5 ANNI
MEMORY
I pericoli a casa



Pentola

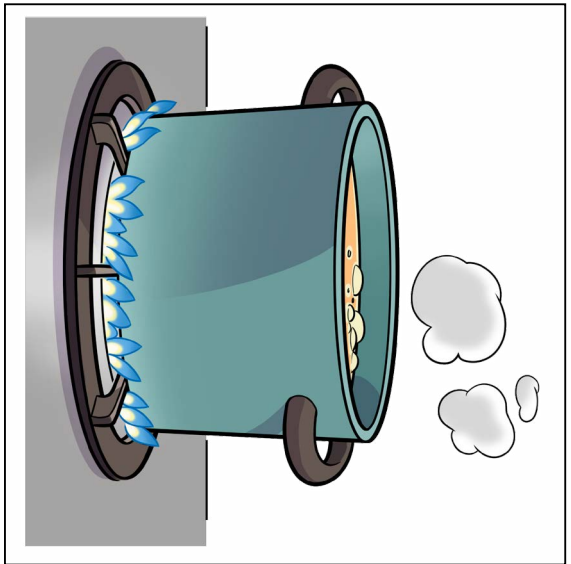

3-5 ANNI
MEMORY
I pericoli a casa



Scale

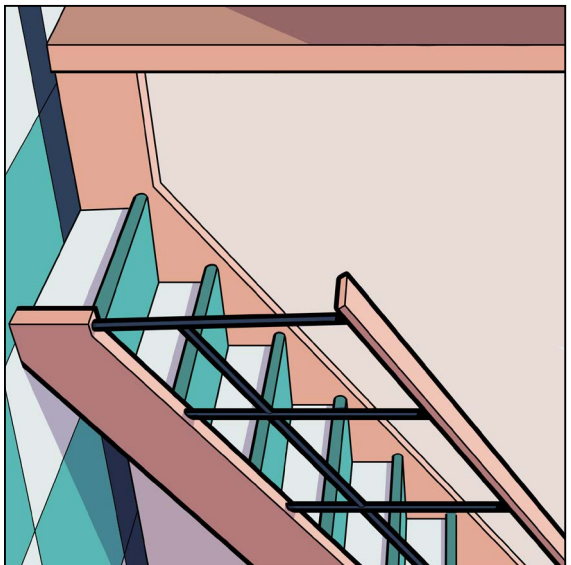

3-5 ANNI
MEMORY
I pericoli a casa



Accendino

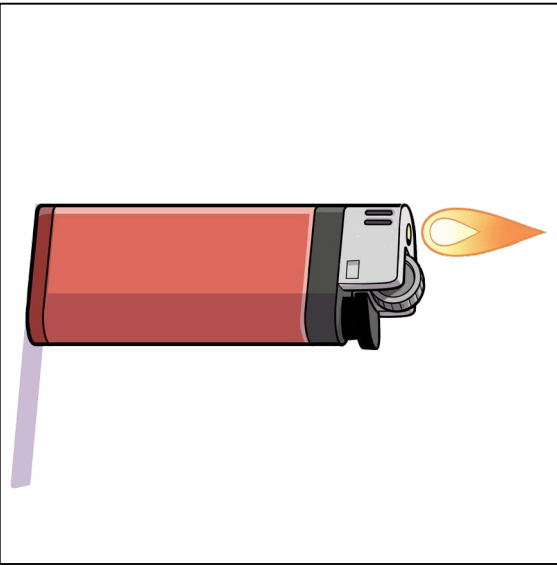

3-5 ANNI
MEMORY
I pericoli a casa



Fiacone



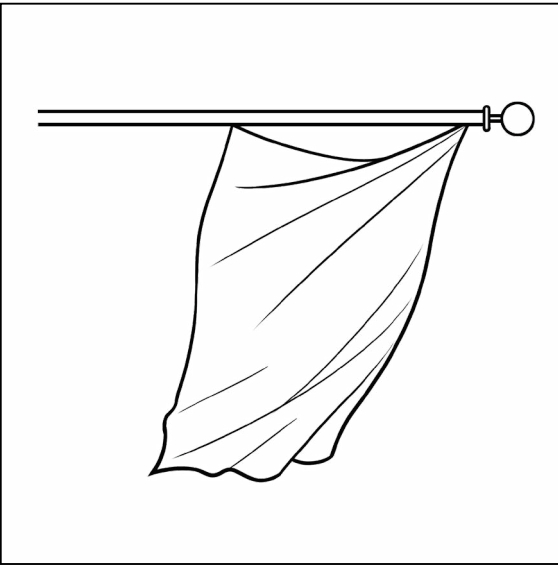

3-5 ANNI
MEMORY
I pericoli al mare



Bandiera

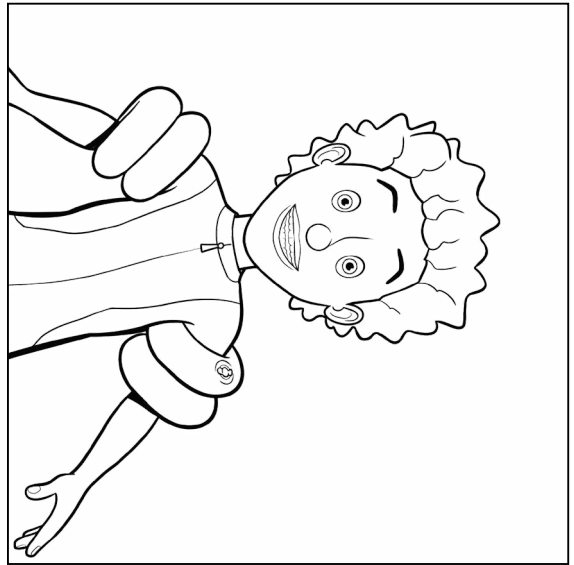

3-5 ANNI
MEMORY
I pericoli al mare



Bracciali

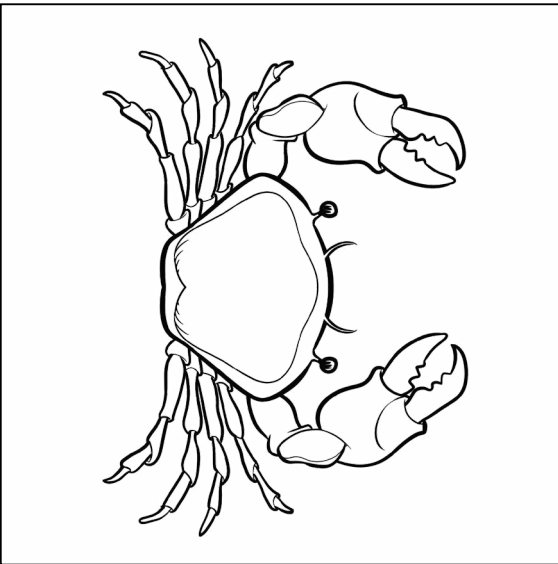

3-5 ANNI
MEMORY
I pericoli al mare



Granchio

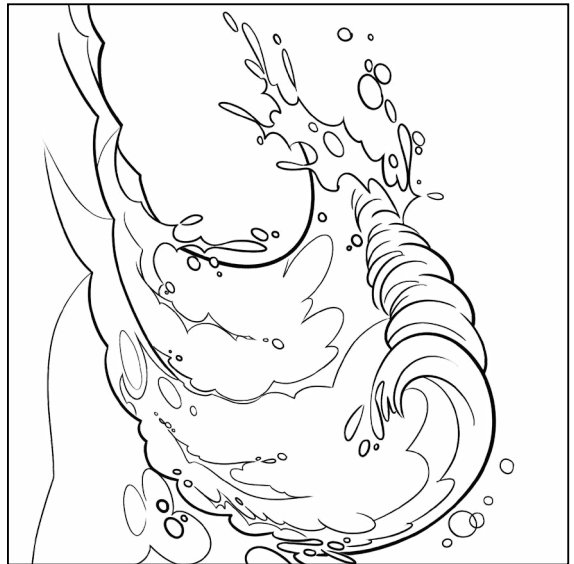

3-5 ANNI
MEMORY
I pericoli al mare



Onda

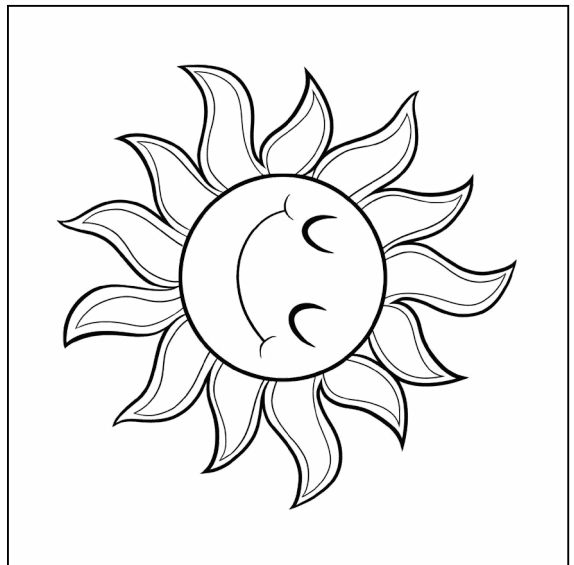

3-5 ANNI
MEMORY
I pericoli al mare



Sole



3-5 ANNI
MEMORY
I pericoli al mare



Bracciali



3-5 ANNI
MEMORY
I pericoli al mare



Bandiera

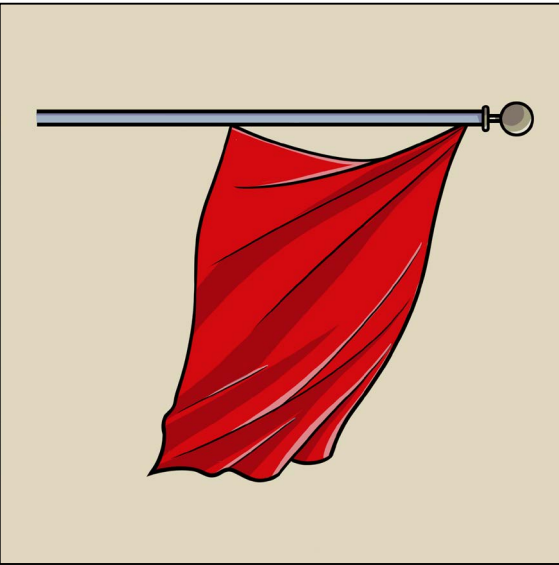

3-5 ANNI
MEMORY
I pericoli al mare



Onda



3-5 ANNI
MEMORY
I pericoli al mare



Granchio

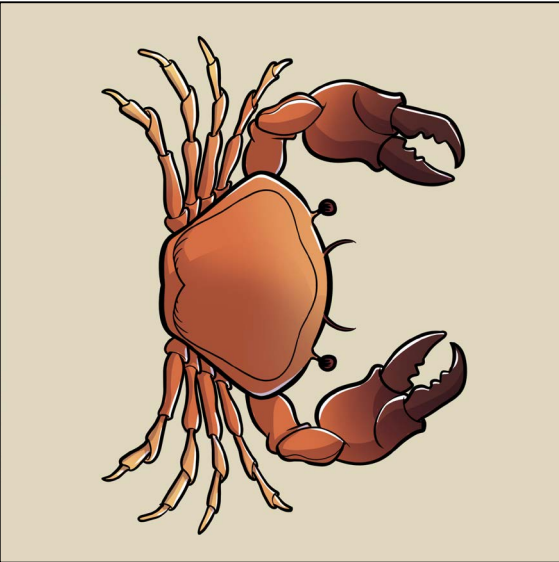

3-5 ANNI
MEMORY
I pericoli al mare



Sole

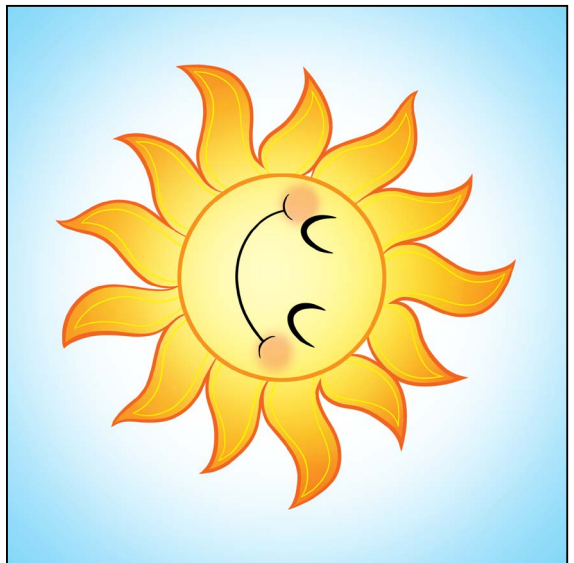

3-5 ANNI
DRAG&DROP
Sicuro, sì o no?



Seggiolino

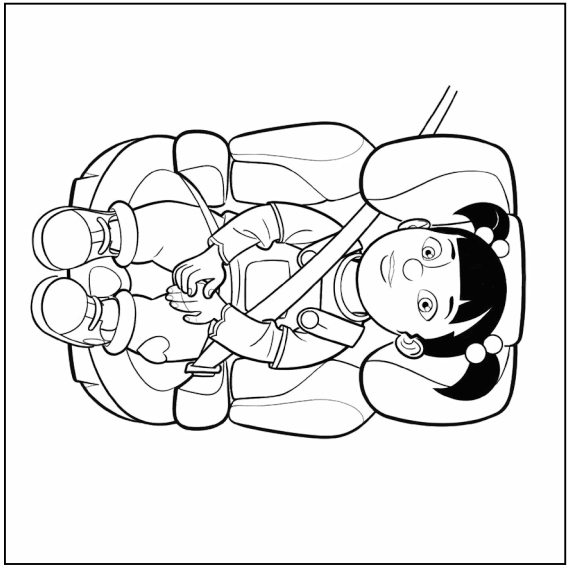

3-5 ANNI
DRAG&DROP
Sicuro, sì o no?



Giubbino



3-5 ANNI
DRAG&DROP
Sicuro, sì o no?



Mano adulto

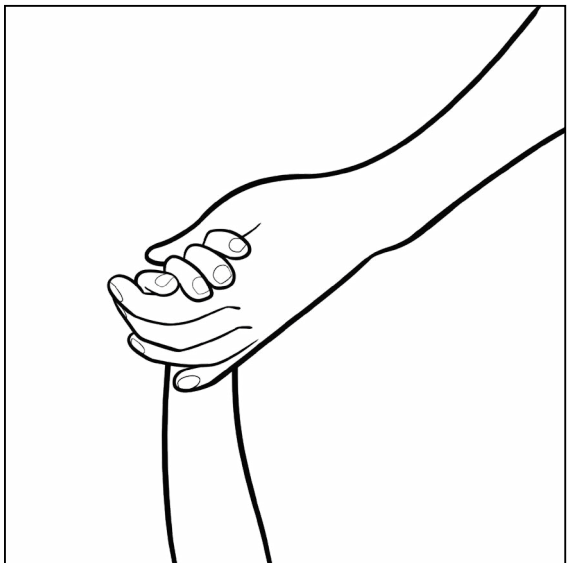

3-5 ANNI
DRAG&DROP
Sicuro, sì o no?



Bambini fila

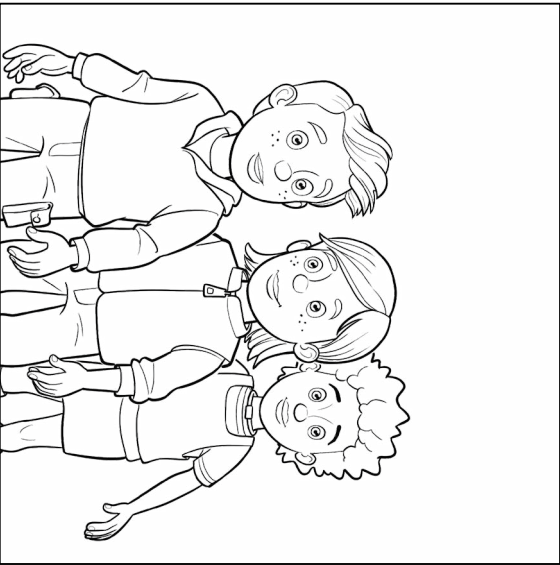

3-5 ANNI
DRAG&DROP
Sicuro, sì o no?



Caschetto

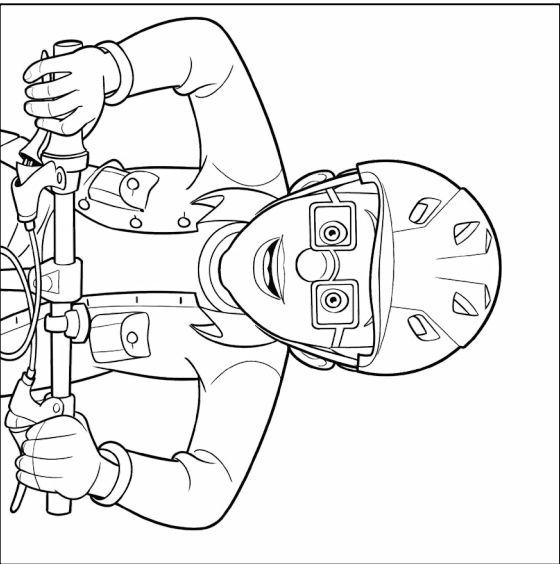

3-5 ANNI
DRAG&DROP
Sicuro, sì o no?



Lavamani



3-5 ANNI
DRAG&DROP
Sicuro, sì o no?



Seggiolino

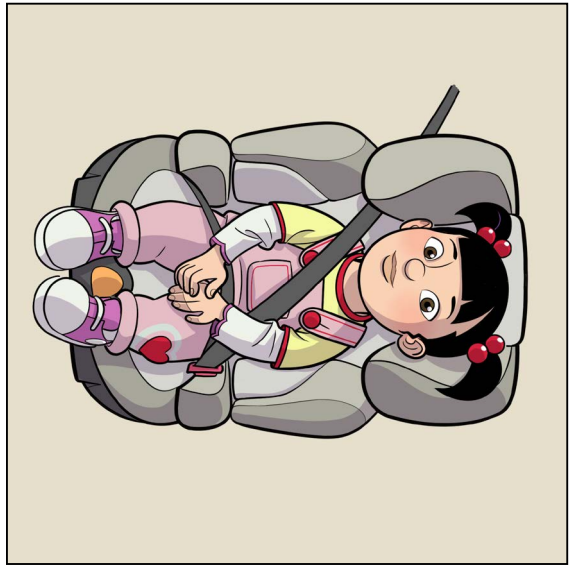

3-5 ANNI
DRAG&DROP
Sicuro, sì o no?



Bambini fila



3-5 ANNI
DRAG&DROP
Sicuro, sì o no?



Giubbino



3-5 ANNI
DRAG&DROP
Sicuro, sì o no?



Cachetto

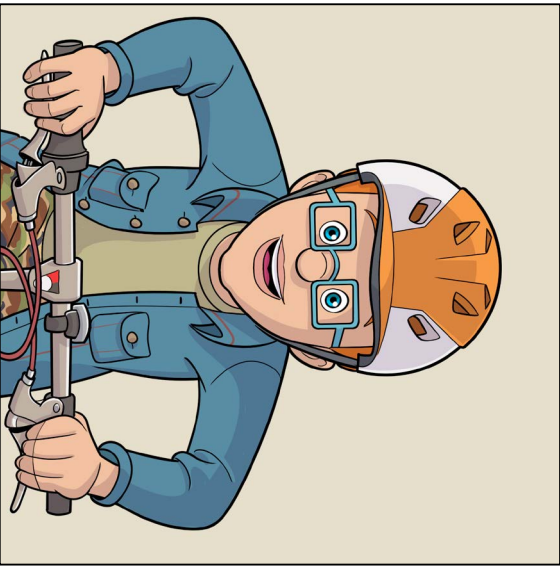

3-5 ANNI
DRAG&DROP
Sicuro, sì o no?



Mano adulto



3-5 ANNI
DRAG&DROP
Sicuro, sì o no?



Lavamani



3-5 ANNI
DRAG&DROP
Sicuro, sì o no?



Giabatta

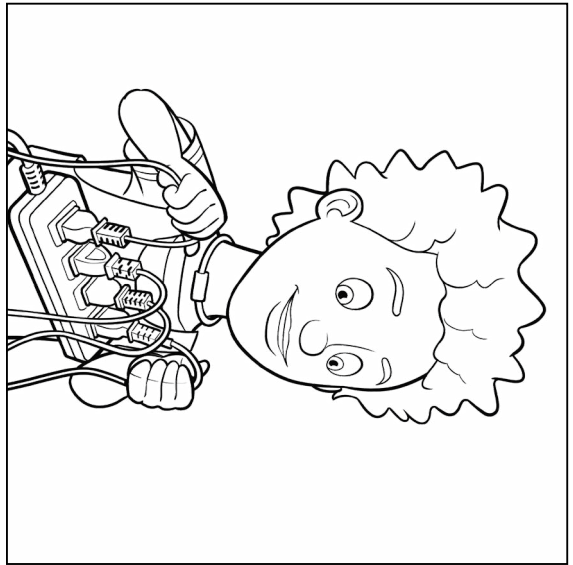

3-5 ANNI
DRAG&DROP
Sicuro, sì o no?



Anta



3-5 ANNI
DRAG&DROP
Sicuro, sì o no?



Piscina



3-5 ANNI
DRAG&DROP
Sicuro, sì o no?



Forbici



3-5 ANNI
DRAG&DROP
Sicuro, sì o no?



Ferro da stiro



3-5 ANNI
DRAG&DROP
Sicuro, sì o no?



Sedia

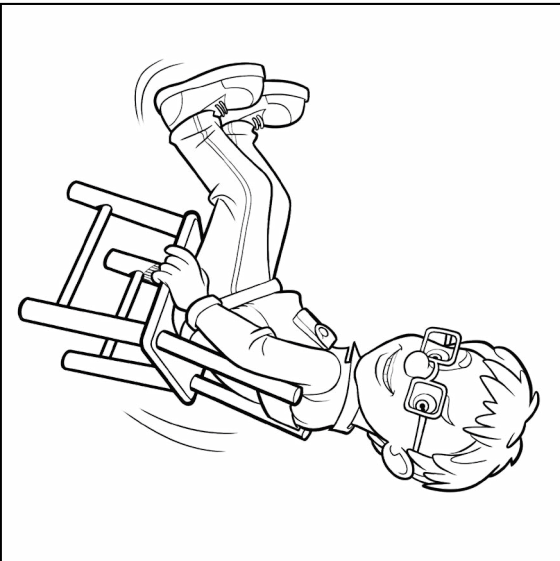

STAMPA
Ritaglia
GIOCA!

3-5 ANNI
DRAG&DROP
Sicuro, sì o no?

3-5 ANNI
DRAG&DROP
Sicuro, sì o no?
PILLOLE SULLA
SALUTE
CON
5 ANNI



Giabatta

3-5 ANNI
DRAG&DROP
Sicuro, sì o no?
PILLOLE SULLA
SALUTE
CON
5 ANNI

Anta



3-5 ANNI
DRAG&DROP
Sicuro, sì o no?
PILLOLE SULLA
SALUTE
CON
5 ANNI

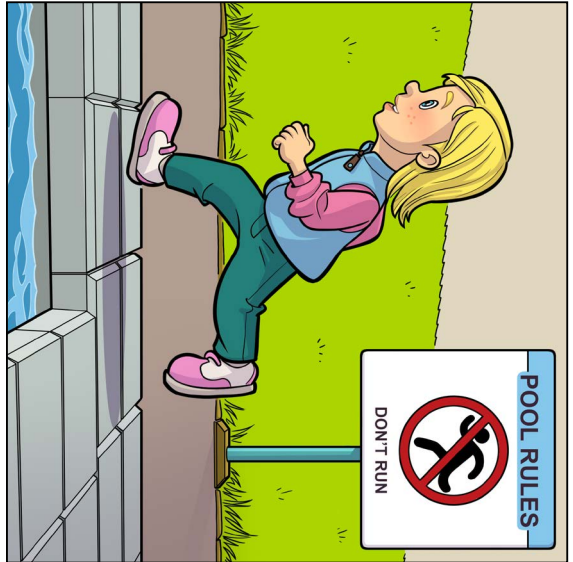

Piscina

3-5 ANNI
DRAG&DROP
Sicuro, sì o no?
PILLOLE SULLA
SALUTE
CON
5 ANNI

Forbici



3-5 ANNI
DRAG&DROP
Sicuro, sì o no?
PILLOLE SULLA
SALUTE
CON
5 ANNI



Ferro da stiro

3-5 ANNI
DRAG&DROP
Sicuro, sì o no?
PILLOLE SULLA
SALUTE
CON
5 ANNI

Sedia



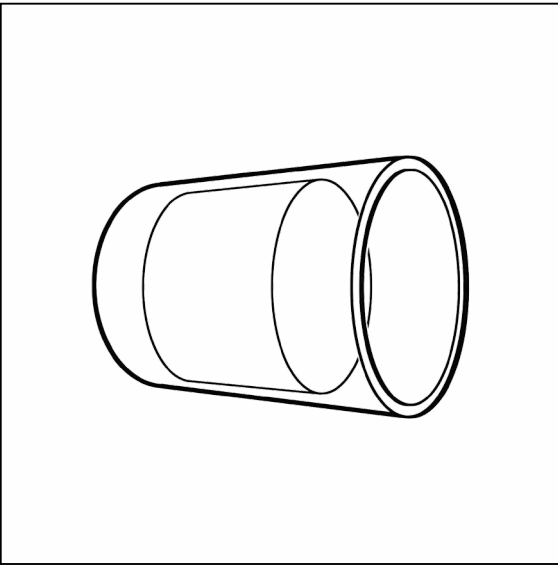

6-7 ANNI
MEMORY
S.O.S. casa



Bicchiere

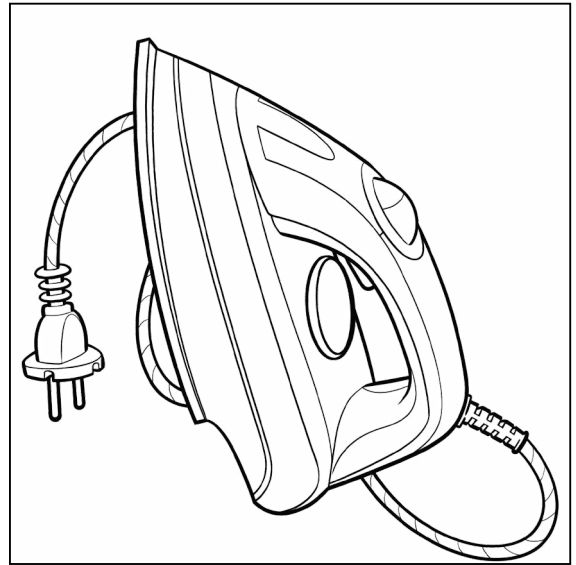

6-7 ANNI
MEMORY
S.O.S. casa



Ferro da stiro

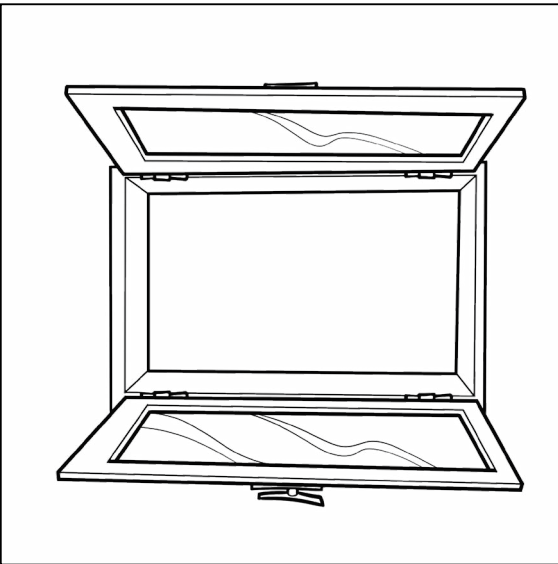

6-7 ANNI
MEMORY
S.O.S. casa



Finestra

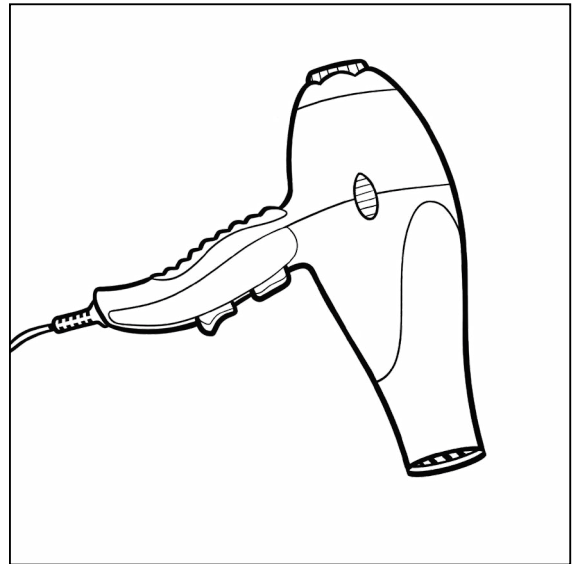

6-7 ANNI
MEMORY
S.O.S. casa



Phon

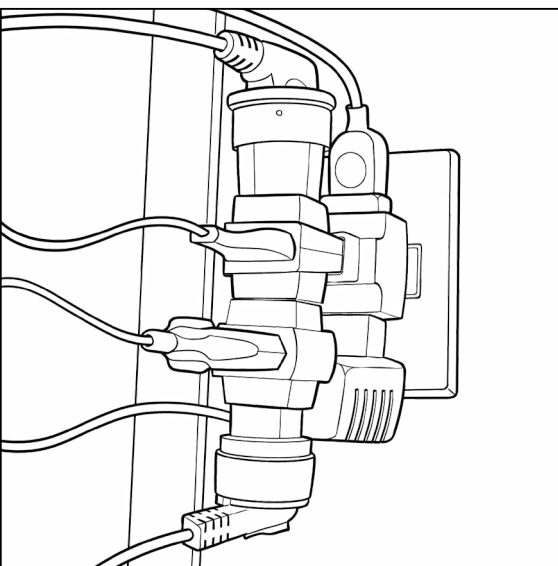

6-7 ANNI
MEMORY
S.O.S. casa



Presca

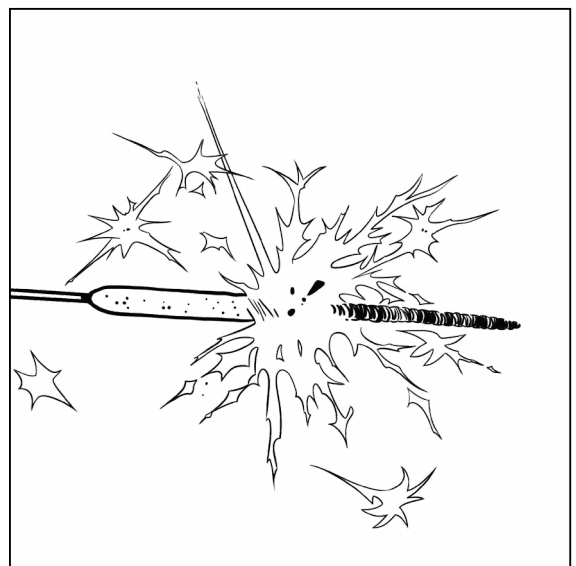

6-7 ANNI
MEMORY
S.O.S. casa



Stelline





6-7 ANNI
MEMORY
S.O.S. casa



Bicchiere

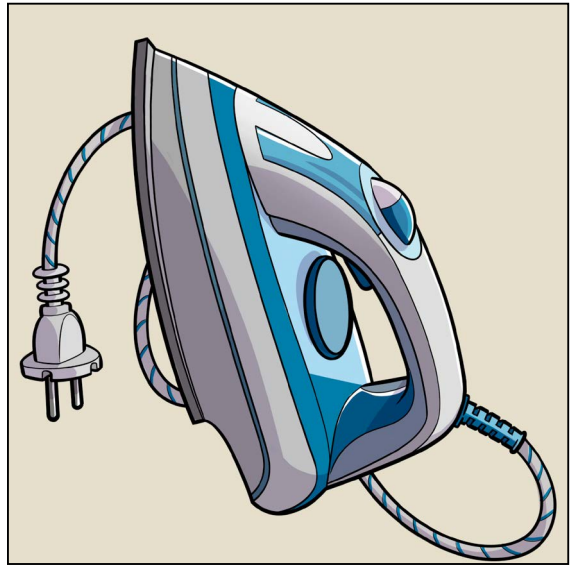

6-7 ANNI
MEMORY
S.O.S. casa



Ferri da stiro



6-7 ANNI
MEMORY
S.O.S. casa



Finestra

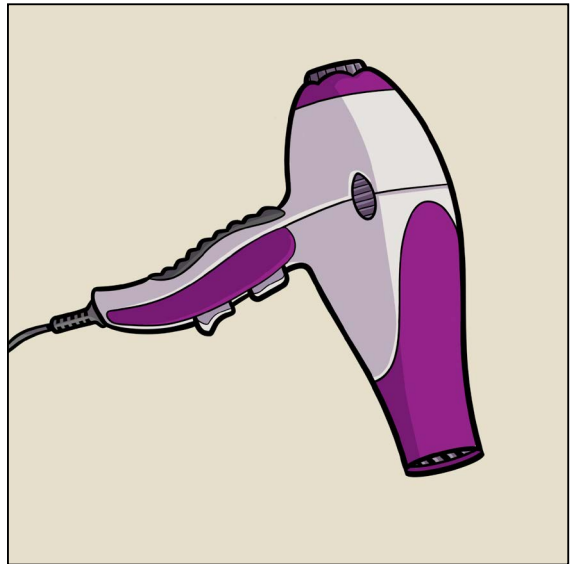

6-7 ANNI
MEMORY
S.O.S. casa



Phon

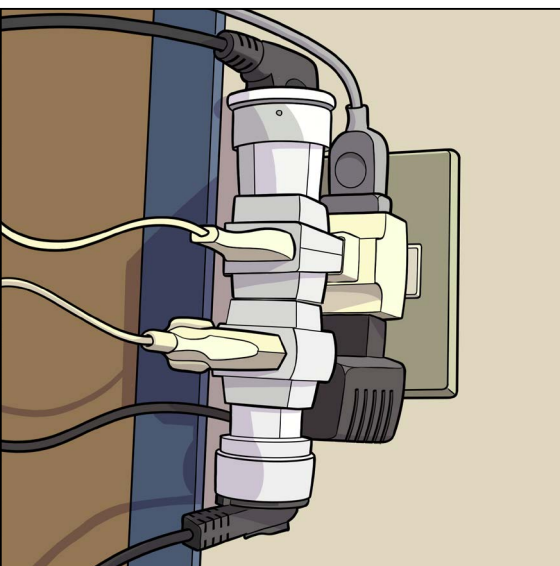

6-7 ANNI
MEMORY
S.O.S. casa



Presca

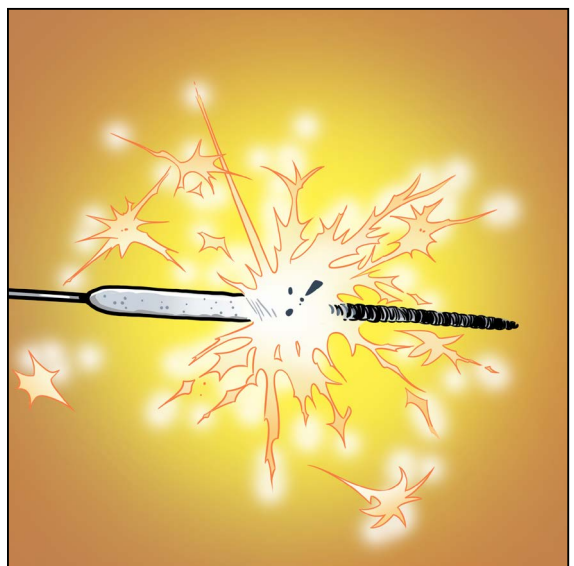

6-7 ANNI
MEMORY
S.O.S. casa



Stelline



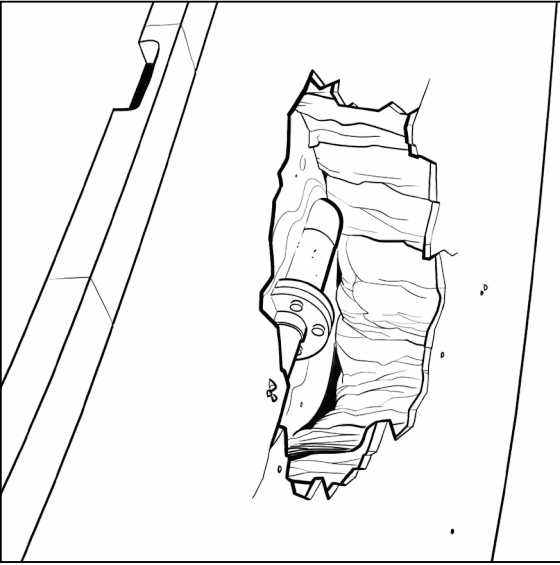

6-7 ANNI
MEMORY
Sicuri per strada



Buca

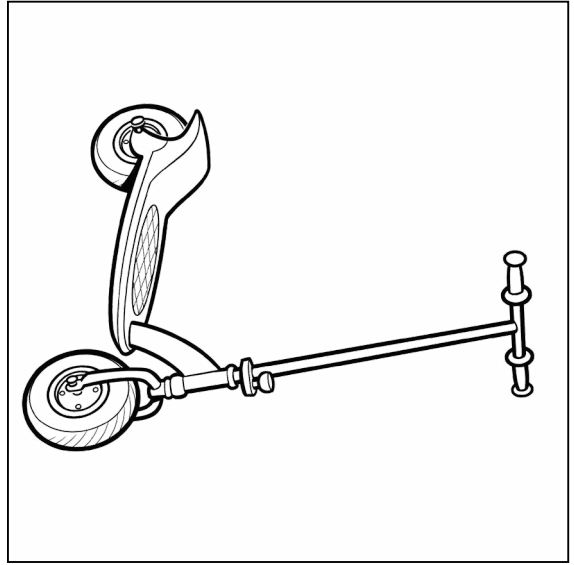

6-7 ANNI
MEMORY
Sicuri per strada



Monopattino

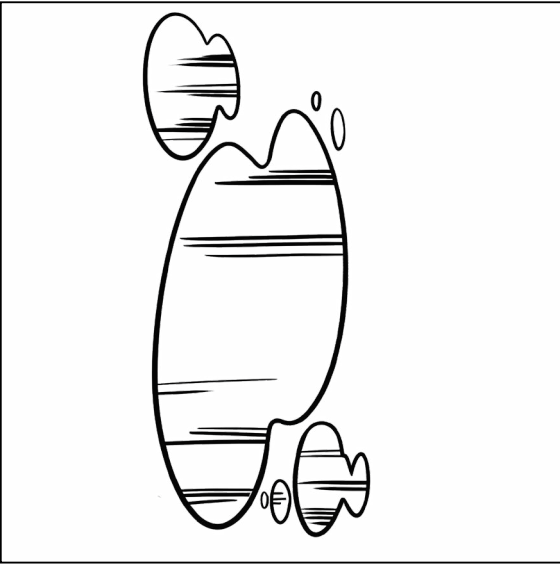

6-7 ANNI
MEMORY
Sicuri per strada



Pozzanghera

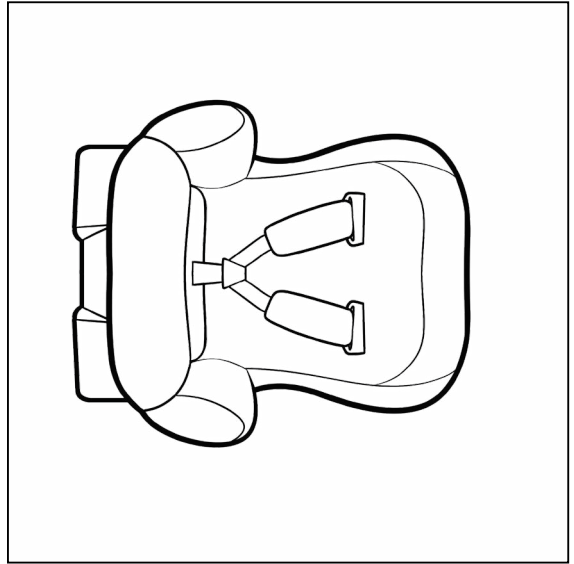

6-7 ANNI
MEMORY
Sicuri per strada



Seggiolino

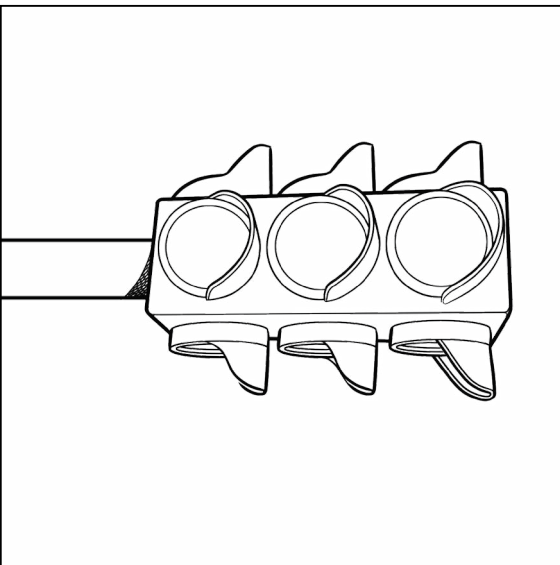

6-7 ANNI
MEMORY
Sicuri per strada



Semaforo

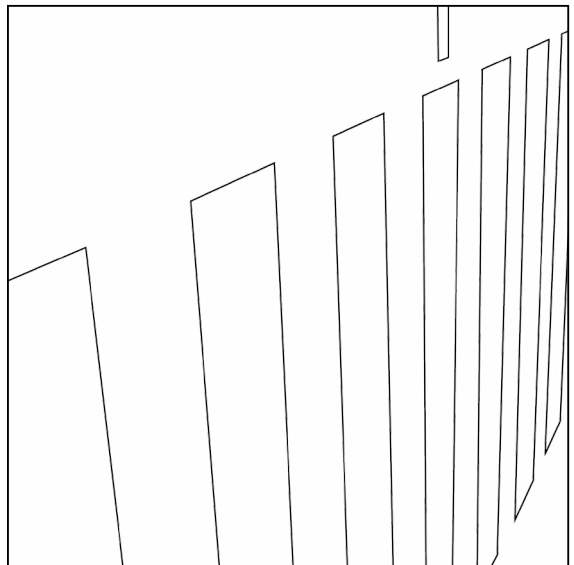

6-7 ANNI
MEMORY
Sicuri per strada



Strisce





6-7 ANNI
MEMORY
Sicuri per strada



Buca

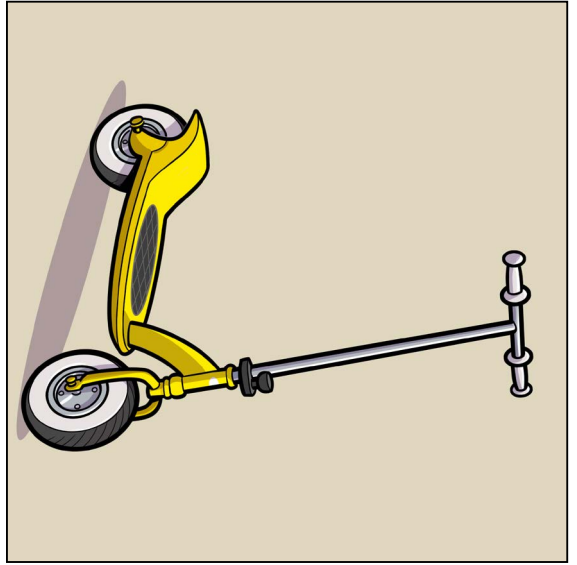

6-7 ANNI
MEMORY
Sicuri per strada



Monopattino

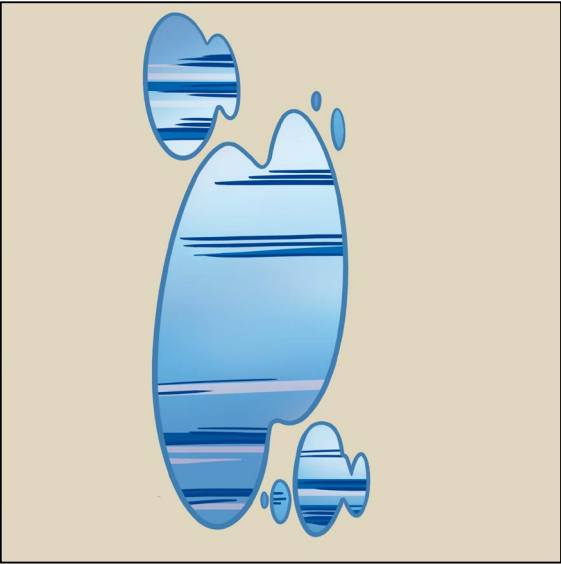

6-7 ANNI
MEMORY
Sicuri per strada



Pozzanghera

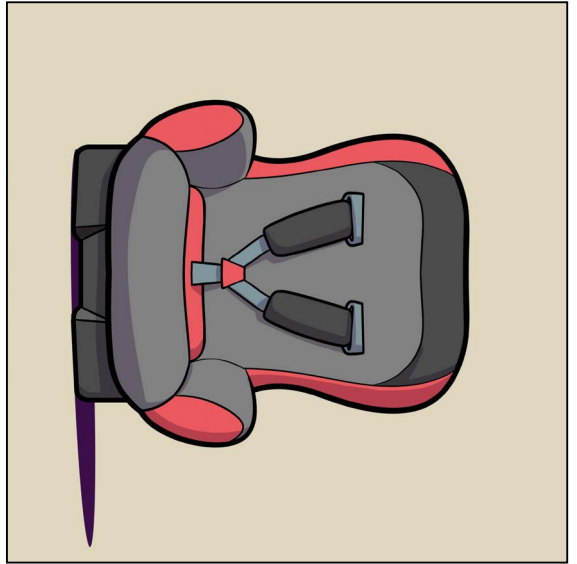

6-7 ANNI
MEMORY
Sicuri per strada



Seggiolino

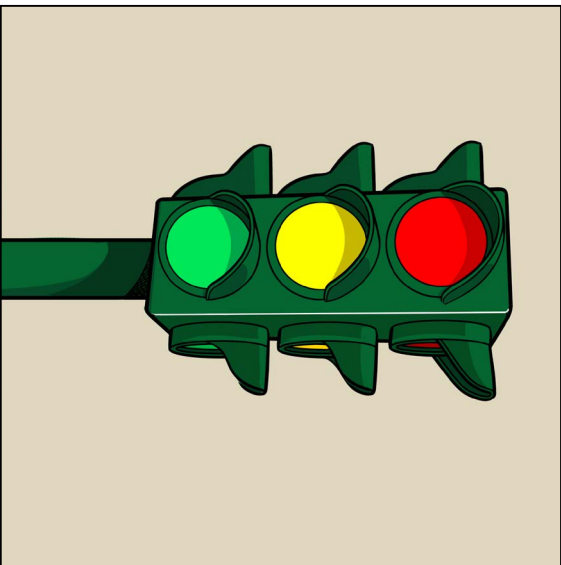

6-7 ANNI
MEMORY
Sicuri per strada



Semaforo



6-7 ANNI
MEMORY
Sicuri per strada



Strisce



STAMPA
Ritaglia
COMPONI

6-7 ANNI
PUZZLE
Tutti al parco!

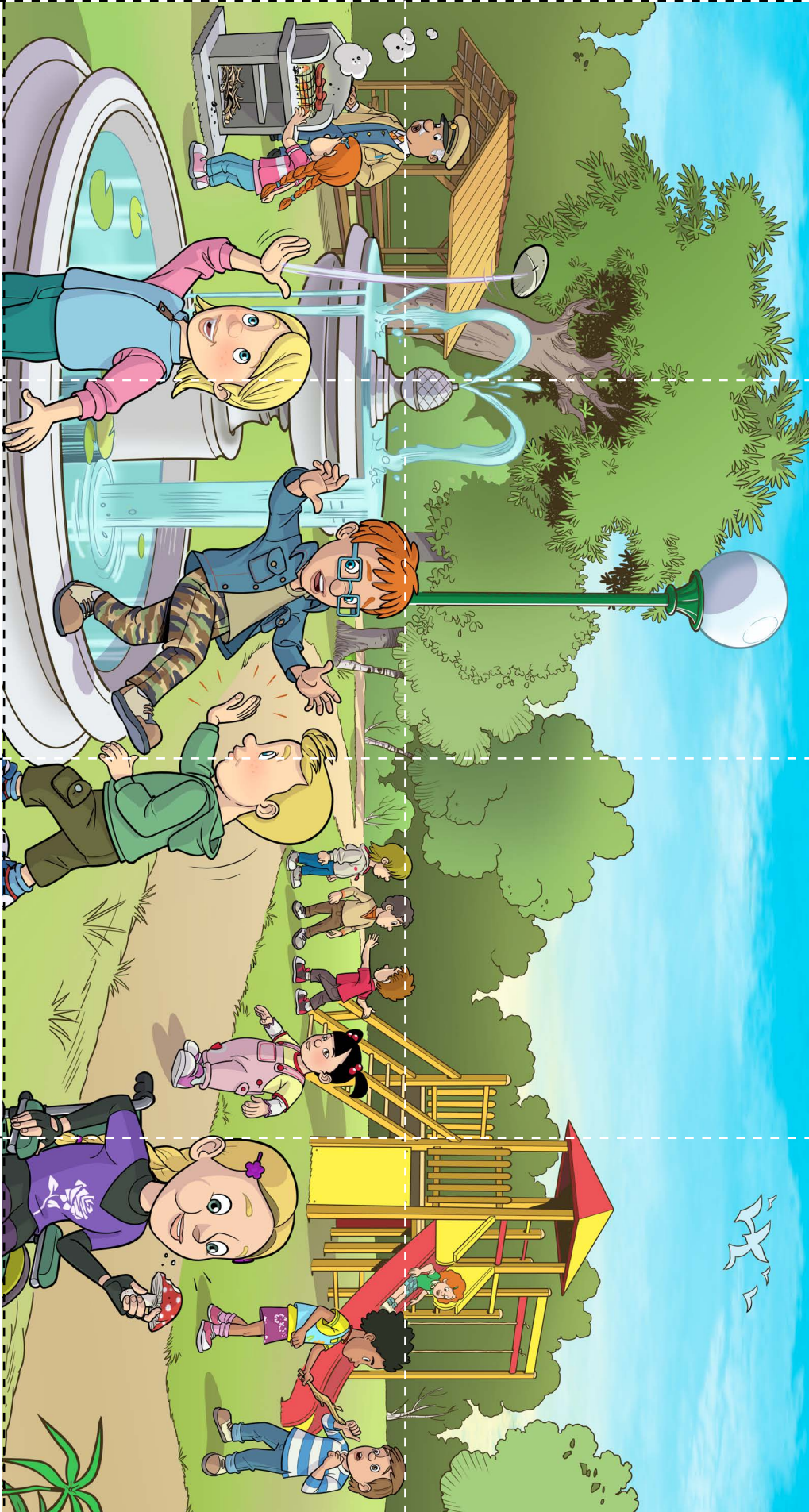

6-7 ANNI
FOTOQUIZ
Caccia alle parole...
di sicurezza



Casco

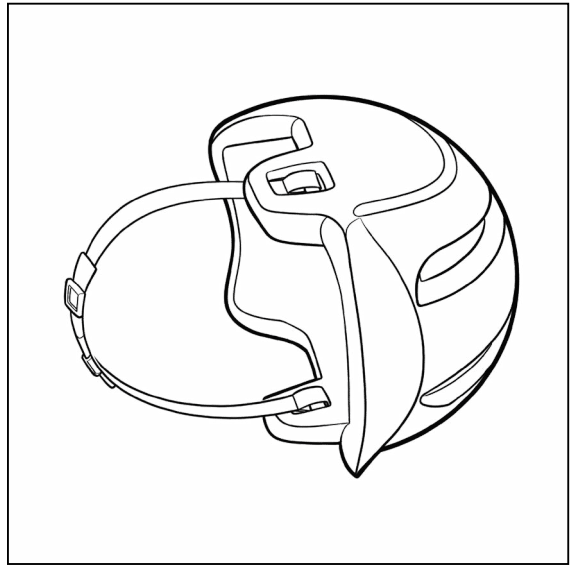

6-7 ANNI
FOTOQUIZ
Caccia alle parole...
di sicurezza



Fiammiferi

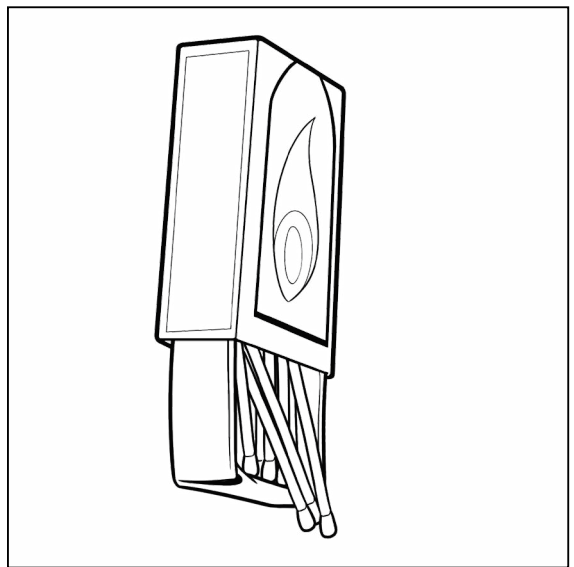

6-7 ANNI
FOTOQUIZ
Caccia alle parole...
di sicurezza



Alcalena

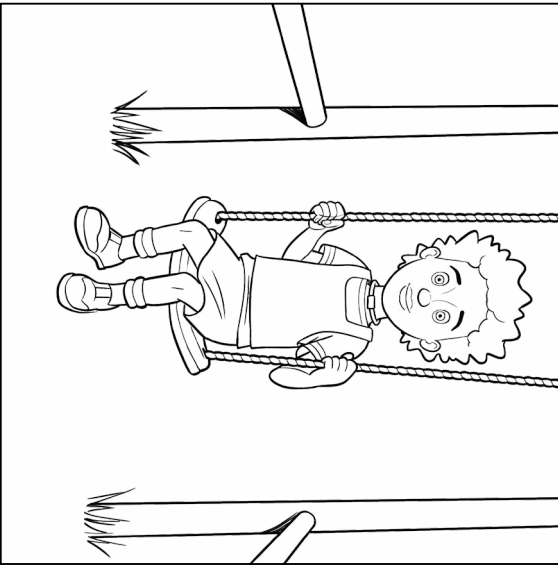

6-7 ANNI
FOTOQUIZ
Caccia alle parole...
di sicurezza



Crema



6-7 ANNI
FOTOQUIZ
Caccia alle parole...
di sicurezza



Guanto

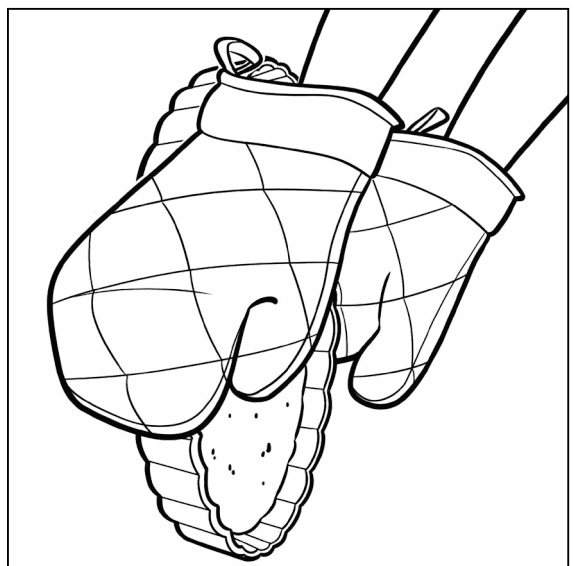

6-7 ANNI
FOTOQUIZ
Caccia alle parole...
di sicurezza



Forbici

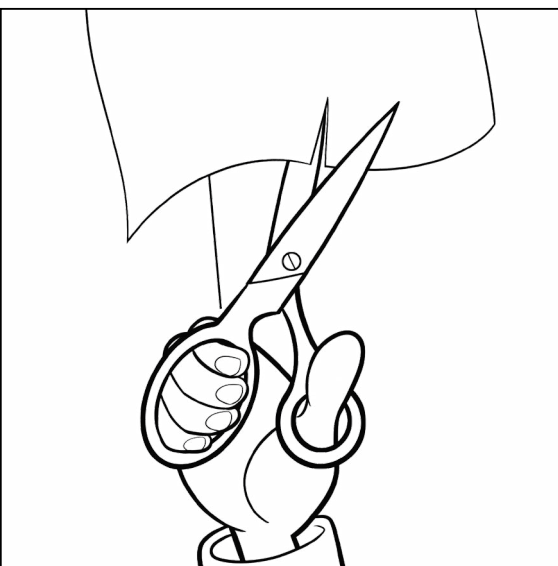

6-7 ANNI
FOTOQUIZ
Caccia alle parole...
di sicurezza



Casco

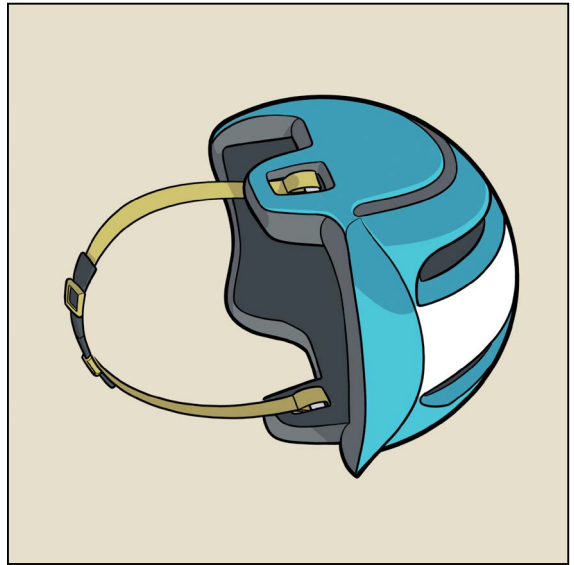

6-7 ANNI
FOTOQUIZ
Caccia alle parole...
di sicurezza



Fiammiferi

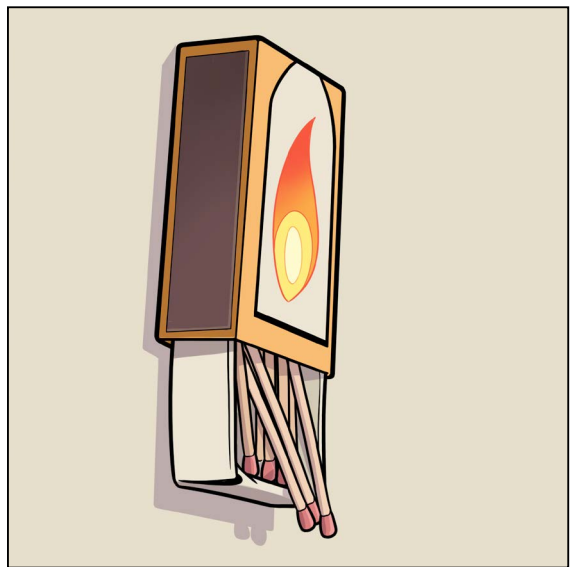

6-7 ANNI
FOTOQUIZ
Caccia alle parole...
di sicurezza



Alcalena

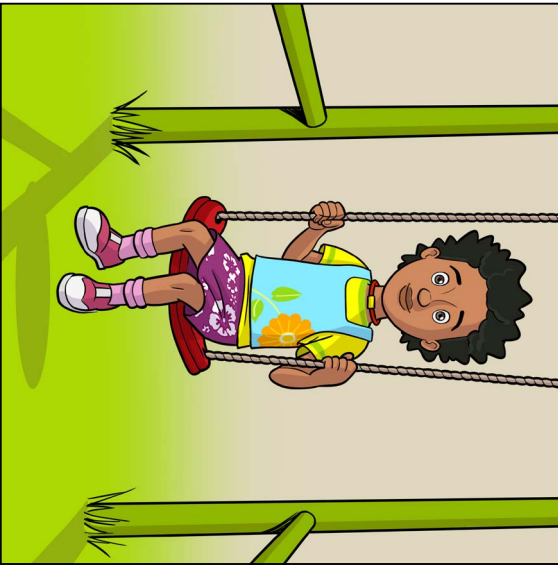

6-7 ANNI
FOTOQUIZ
Caccia alle parole...
di sicurezza



Crema



6-7 ANNI
FOTOQUIZ
Caccia alle parole...
di sicurezza



Guanto

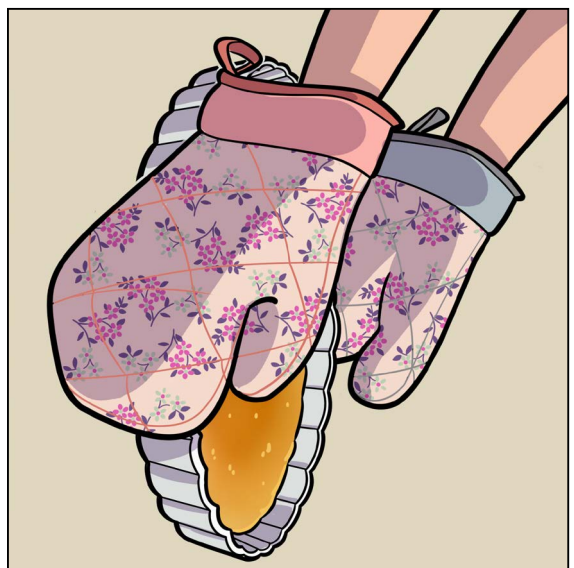

6-7 ANNI
FOTOQUIZ
Caccia alle parole...
di sicurezza



Forbici

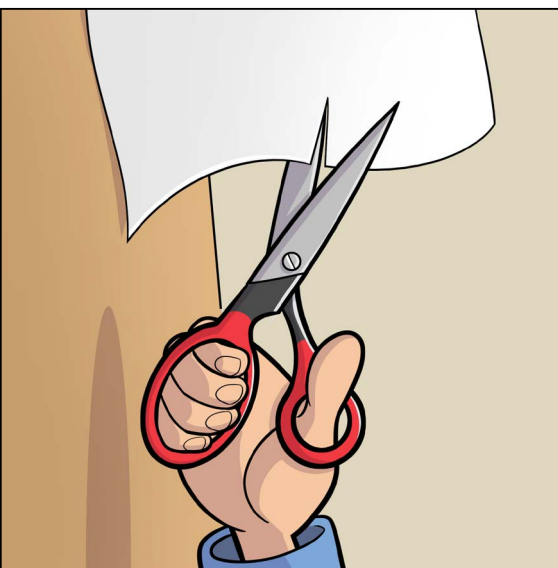

6-7 ANNI
FOTOQUIZ
Caccia alle parole...
di sicurezza



Scossa



6-7 ANNI
FOTOQUIZ
Caccia alle parole...
di sicurezza



Medicine

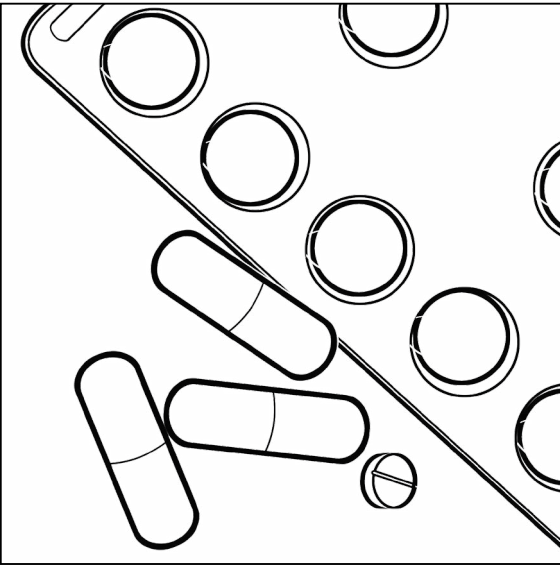

6-7 ANNI
FOTOQUIZ
Caccia alle parole...
di sicurezza



Veleno

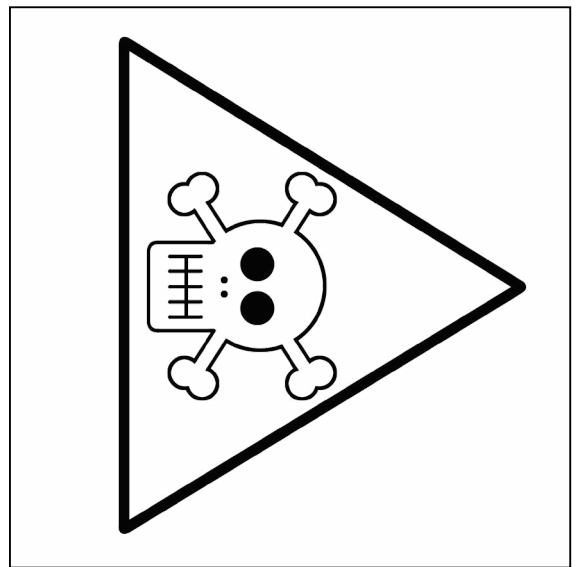

6-7 ANNI
FOTOQUIZ
Caccia alle parole...
di sicurezza



Spigolo

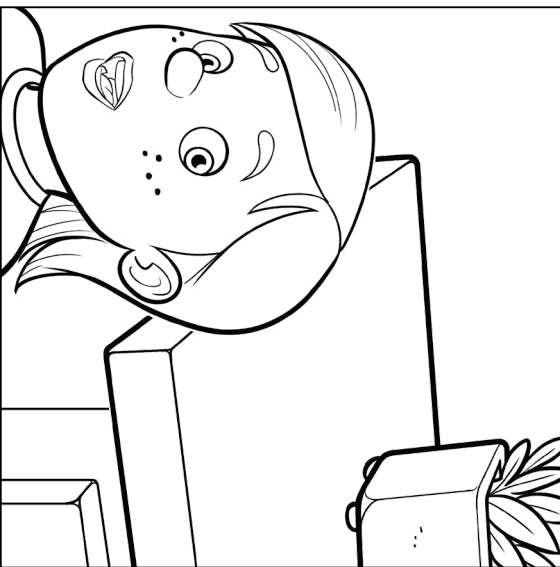

6-7 ANNI
FOTOQUIZ
Caccia alle parole...
di sicurezza



Scossa



6-7 ANNI
FOTOQUIZ
Caccia alle parole...
di sicurezza



Veleno

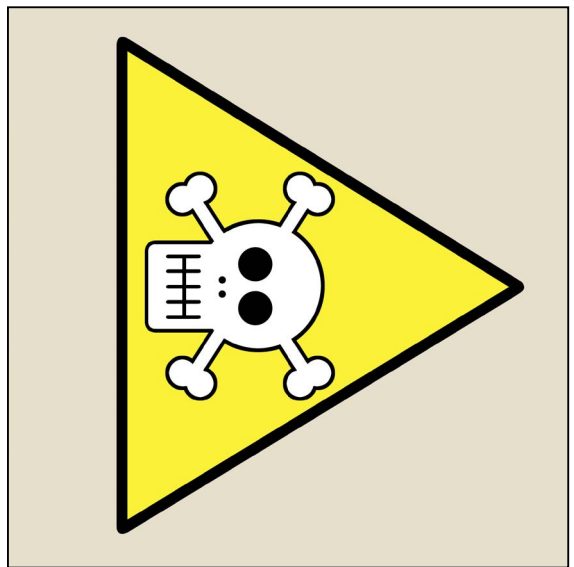

6-7 ANNI
FOTOQUIZ
Caccia alle parole...
di sicurezza



Medicine



6-7 ANNI
FOTOQUIZ
Caccia alle parole...
di sicurezza



Spigolo



STAMPA
Ritaglia
GIOCA!

PER TUTTI
DRAG&DROP
Prima o dopo?

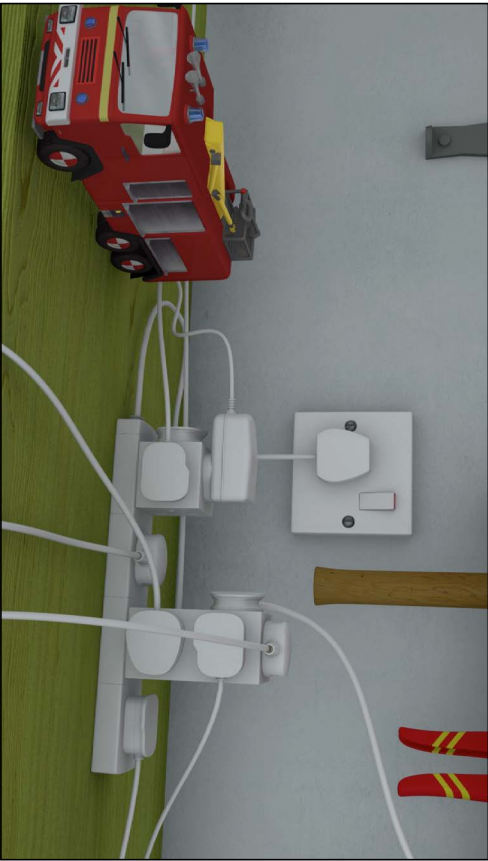

PER TUTTI
DRAG&DROP
Prima o dopo?

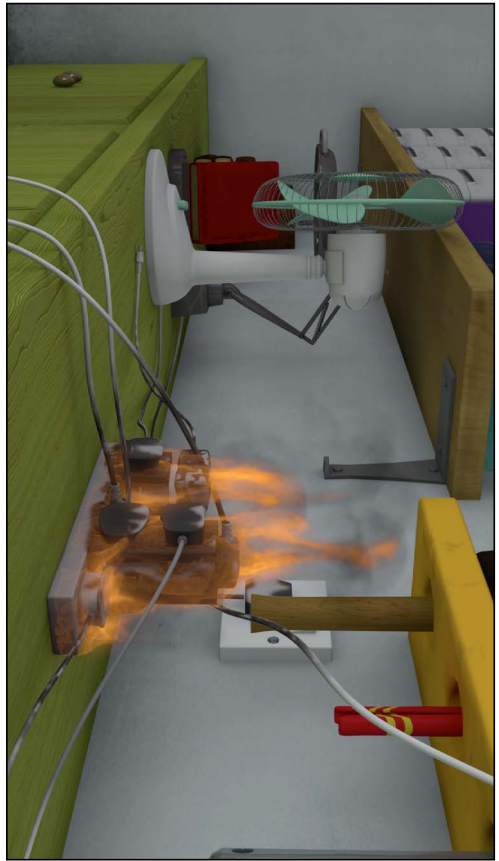

PER TUTTI
DRAG&DROP
Prima o dopo?



PER TUTTI
DRAG&DROP
Prima o dopo?



STAMPA
Ritaglia
GIOCA!

PER TUTTI
DRAG&DROP
Prima o dopo?



PER TUTTI
DRAG&DROP
Prima o dopo?

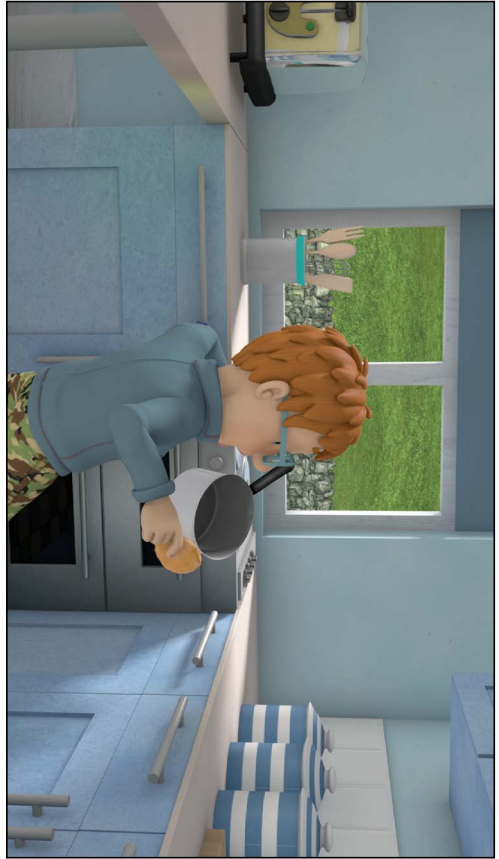

PER TUTTI
DRAG&DROP
Prima o dopo?



PER TUTTI
DRAG&DROP
Prima o dopo?



STAMPA
Ritaglia
GIOCA!

PER TUTTI
DRAG&DROP
Prima o dopo?

PER TUTTI
DRAG&DROP
Prima o dopo?



PER TUTTI
DRAG&DROP
Prima o dopo?

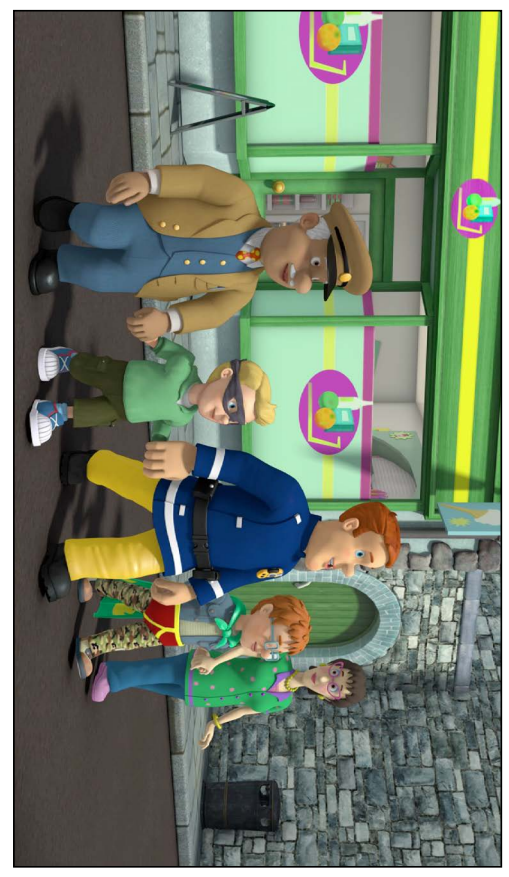

PER TUTTI
DRAG&DROP
Prima o dopo?



